

FASENFRÄSEN von Vieleck- und Rundmaterial

Spanntech by System KOPAL

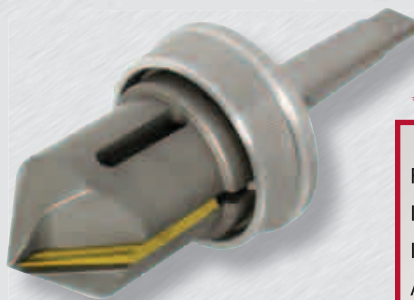
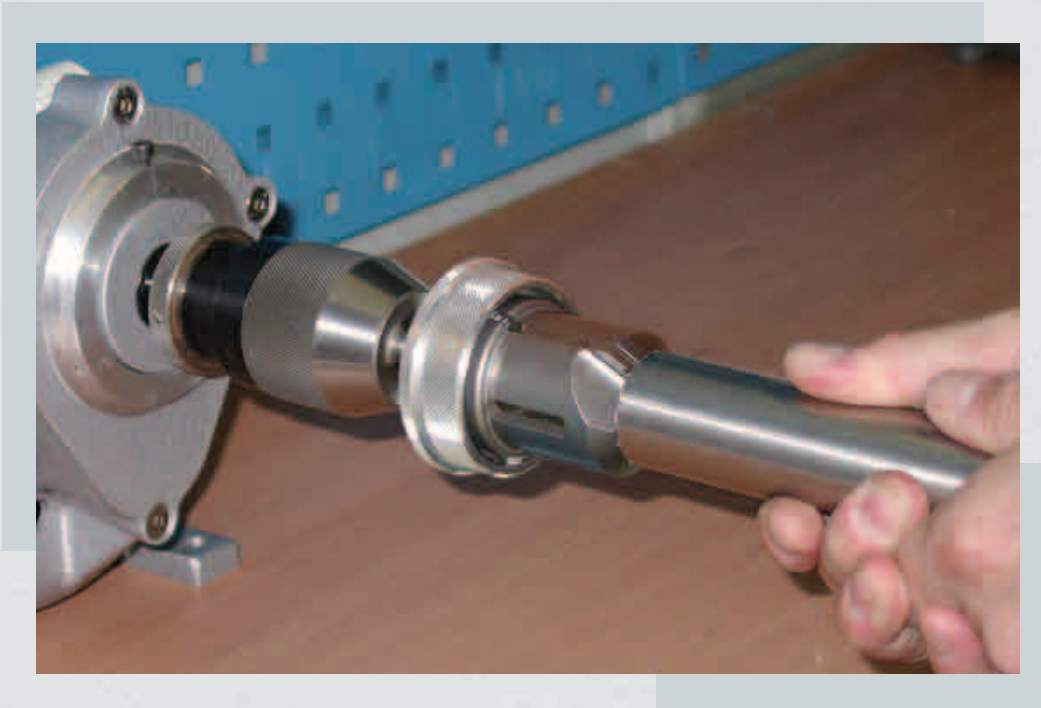

FASENFRÄSEN

- Fasenfräsenprinzip
- Innenfaser
- Innenfaser - Slim Line
- Aussenfaser
- Fasenfräser für Rohre - KOPAL Tube
- Ersatzteile
- Ersatz-Messer

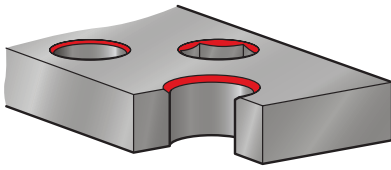

Fräst Fasen an Bohrungen, Viel- und mehreckigen Kanten. Unterbrochene Schnitte werden mittels des federnden Führungskegel schonend entgratet.

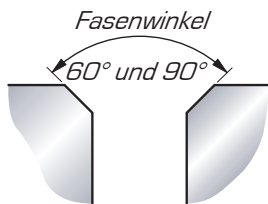

Slim Line mit langer und schlanker Bauweise. Ermöglicht effektives Arbeiten bei geringem Arbeitsraum.



Innenfaser - SLIM LINE

ohne Messer ⚠

Führungskegel Standard

Durchm. der Faser	Modell	Befest.	A	B 60°/90°	60°	90°
					Best. Nr.	Best. Nr.
4 bis 17	3 - 19	Ø 10 6-kant 6.35	Ø 19.5	78/68	03-015	03-010 03-011
11 bis 30	10 - 30	CM 1	Ø 32	112/100	03-035	03-020
		CM 2			03-036	03-021
		Ø 12			03-040	03-025
5 bis 40	4 - 42	CM 2	Ø 44	135		03-051
		Weldon Ø 20			03-053	
		Ø 12.7			03-055	

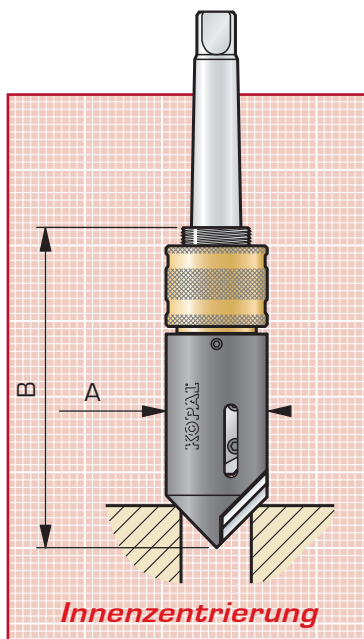

HSS-Messer
Spanwinkel 0° - 14° - 20°
und 25°
Hartmetall-Messer
Spanwinkel 0°

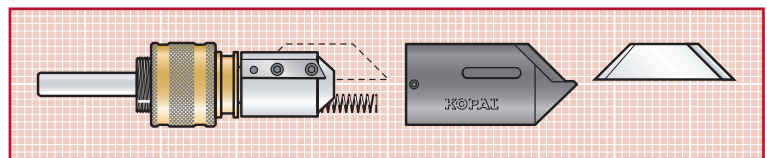
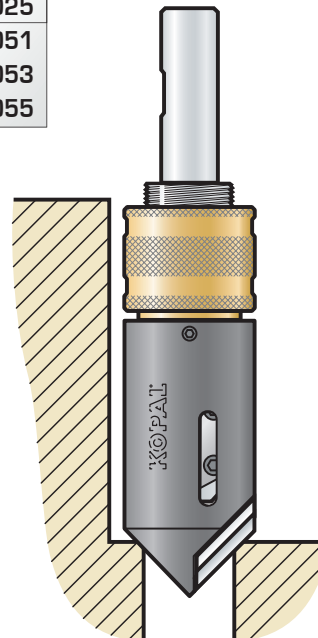

Innenmesser

Spanwinkel 0° für Modell :	60°	90°	82°	120°	60°	90°
	HSS				Hartmetall	
	01-303	01-323		01-334		
	2 - 18	01-343	01-353	01-336	01-364	
2 - 42	01-363	01-373			01-341	01-351
20 - 60 bis 80 - 120						

Spanwinkel 14° für Modell :	60°	90°	82°	120°
	HSS			
	01-305	01-320		01-335
	2 - 18	01-340	01-350	01-345
2 - 42	01-365	01-370		
20 - 60 bis 80 - 120				

Spanwinkel 20° für Modell :	60°	90°	82°	120°	60°	90°
	HSS				TIN	
	01-308	01-328		01-338	1T305B	1T320B
	2 - 18	01-348	01-358	01-342	01-368	
2 - 42	01-361	01-378			1T340B	1T350B
20 - 60 bis 80 - 120						

Spanwinkel 25° für Modell :	60°	90°	82°	120°
	HSS			
	01-309	01-329		01-339
	2 - 18	01-349	01-359	01-344
2 - 42	01-362	01-379		
20 - 60 bis 80 - 120				

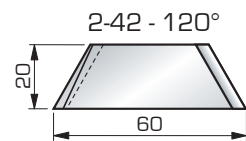
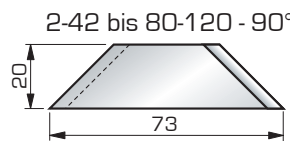
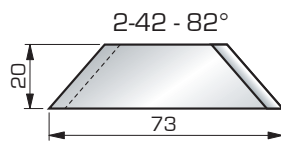
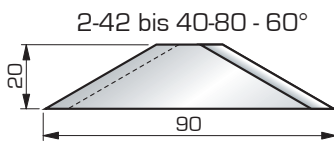
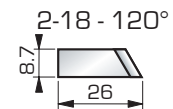
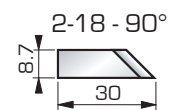
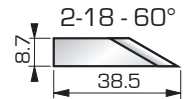
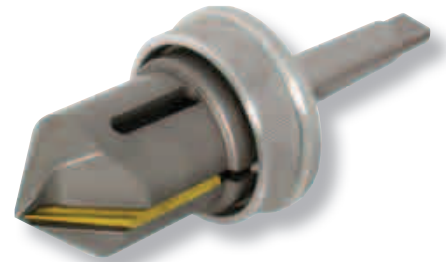

- HSS-Messer - 0° bis 25°
Standard Werkstoffe.
- HSS-Messer - TIN - 20°
Schwierigste Bearbeitung:
rostfreier Stahl, Inconel, Titanium.
- Hartmetall-Messer - 0°
geeignet für hartes Material.

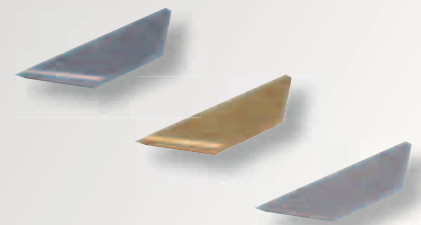

Aussenmesser

Spanwinkel 0° für Modell :	60°	90°
	HSS	
	02-303	02-304
	2 - 18	
2 - 36 bis 80 - 120	02-317	02-312

Spanwinkel 14° für Modell :	60°	90°
	HSS	
	02-305	02-300
	2 - 18	
2 - 36 bis 80 - 120	02-315	02-310

Spanwinkel 20° für Modell :	60°	90°	60°	90°
	HSS		TIN	
	02-308	02-302	2T305B	2T300B
	2 - 18	02-318	02-313	2T315B
2 - 36 bis 80 - 120			2T310B	

Spanwinkel 25° für Modell :	60°	90°
	HSS	
	02-307	02-306
	2 - 18	
2 - 36 bis 80 - 120	02-319	02-314

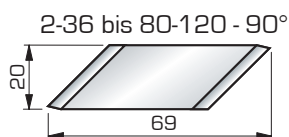
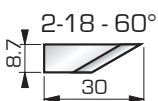
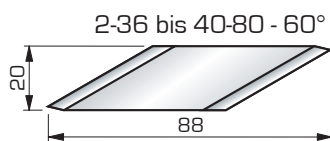
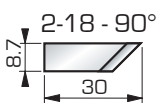

Innenmesser für Slim Line

Spanwinkel 0° für Modell :	60° HSS	90° HSS	90° Hartmetall
3 - 19	03-312	03-322	
10 - 30	03-302	03-321	
4 - 42		03-352	01-351
Spanwinkel 14° für Modell :	60° HSS	90° HSS	
3 - 19	03-310	03-320	
10 - 30	03-305	03-300	
4 - 42		03-350	
Spanwinkel 20° für Modell :	60° HSS	90° HSS	
3 - 19	03-313	03-323	
10 - 30	03-308	03-328	
4 - 42		03-358	
Spanwinkel 25° für Modell :	60° HSS	90° HSS	
3 - 19	03-314	03-324	
10 - 30	03-309	03-329	
4 - 42		03-359	

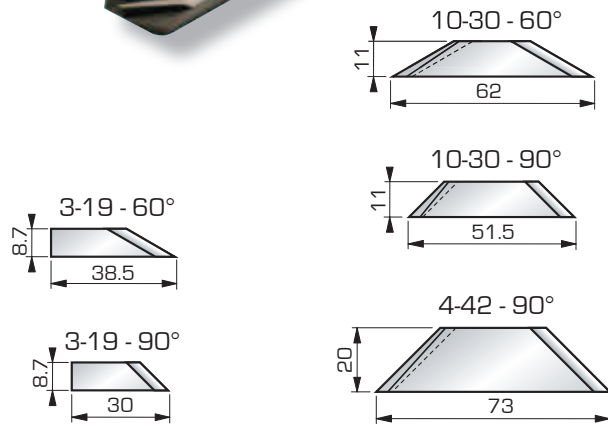

	Messing	Stahl	Stahl	Aluminium
	Bronze	Spezialbronze	Kupfer	Weicheisen
Material	Gusseisen	Plexiglas	AU 4 G	Bleche
	rostfreier Stahl		Kunststoff	
	hitzebeständiger Stahl		rostfreier Stahl	
Spanwinkel	0° HSS Hartmetall	14° HSS	20° HSS	25° HSS

Funktionell kann man den Senker mit einem Schreinerhobel vergleichen .

Durch den Messervorstand bekommt man eine Spandicke pro Schneide.

Z.B. : mit 0,1 mm Messervorstand sind 10 Runden notwendig, um eine Fase von 1 mm zu fertigen.

empfohlene Schnittgeschwindigkeit

zwischen 10 und 20 m/min.

z. B. : Ø 10 mm	320 bis 640 rpm
Ø 15 mm	210 bis 420 rpm
Ø 20 mm	160 bis 320 rpm
Ø 30 mm	110 bis 220 rpm
Ø 40 mm	80 bis 160 rpm
Ø 60 mm	55 bis 110 rpm

$$U/min = \frac{\text{Schnittgeschwindigkeit} \times 1000}{\text{Durchmesser} \times 3.14}$$

Schmieren mit Schneidöl oder Emulsionsöl, um längste Standzeit des Messers und geringsten Abrieb des Führungskegels zu gewährleisten.

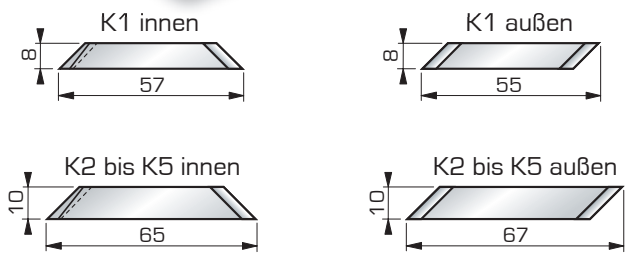
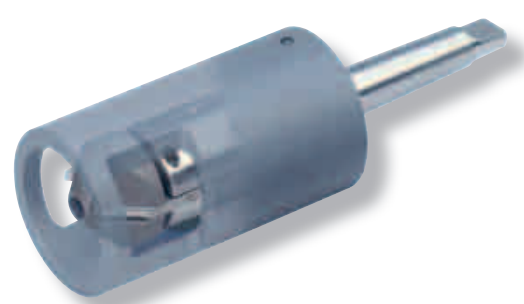

Messer für KOPAL TUBE

Spanwinkel 14° für Modell :	innen HSS	außen HSS
K 1	04-300	04-310
K 2 bis K 5	04-320	04-330
Spanwinkel 20° für Modell :	innen HSS	außen HSS
K 1	04-303	04-313
K 2 bis K 5	04-323	04-333

Führungskegel

für Gerät

Innen	Best. Nr.
2-18 90°	01-510
2-18 60°	01-520
2-18 82°	01-530
2-42 90°	01-550
2-42 60°	01-555
2-42 82°	01-560
2-42 120°	01-570
20-60 90°	01-575
20-60 60°	01-580
40-80 90°	01-590
40-80 60°	01-595
60-100 90°	01-605
80-120 90°	01-620

für Gerät

Innen Slim Line	Best. Nr.
3-19 90°	03-510
3-19 60°	03-515
10-30 90°	03-520
10-30 60°	03-525
4-42 90°	03-530

für Gerät

Außen	Best. Nr.
2-18 90°	02-510
2-18 60°	02-515
2-36 90°	02-520
2-36 60°	02-525
10-46 90°	02-535
10-46 60°	02-540
20-60 90°	02-550
20-60 60°	02-555
40-80 90°	02-565
40-80 60°	02-570
60-100 90°	02-580
80-120 90°	02-595

Mutter

für Gerät

Innen, Außen	Best. Nr.
2-18	01-750
2-42	01-760
20-60	01-770
40-80	01-775
60-100	01-780
80-120	01-785

Innen Slim Line

3-19	03-610
10-30	03-615
4-42	03-620

Gegenmutter

für Gerät

Innen, Außen	Best. Nr.
2-18	01-755
2-42	01-765
20-60	
Innen Slim Line	
3-19	03-611

Feder

für Gerät

Innen, Außen	Best. Nr.
2-18	01-820
2-42	01-825
20-60	01-830
40-80	01-835
60-100	01-837

Innen Slim Line

4-42	03-645
10-30	03-640

Körper

für Gerät

Innen	Best. Nr.
2-18 90° Befest. Cyl.	01-630
2-18 90° Befest. CM 1	01-635
2-18 60° Befest. Cyl.	01-640
2-18 60° Befest. CM 1	01-645
2-42 90° Befest. CM 1	01-650
2-42 90° Befest. CM 2	01-651
2-42 90° Befest. CM 3	01-652
2-42 90° Befest. Ø 10-16	01-655
2-42 90° Befest. Ø 12,7	01-660
2-42 60° Befest. CM 2	01-676
2-42 60° Befest. CM 3	01-677
2-42 60° Befest. Ø 12,7	01-685
20-60 90° Befest. CM 2	01-690
20-60 60° Befest. CM 2	01-695

für Gerät

Innen Slim Line	Best. Nr.
3-19 90°	
3-19 60° Befest. Ø 10	03-555
10-30 90°	
10-30 60° Befest. CM 2	03-561
4-42 90° Befest. CM 2	03-576

für Gerät

Außen	Best. Nr.
2-36 90° Befest. CM 2	02-610
2-36 90° Befest. Ø 10-16	02-615
10-46 90° Befest. CM 2	02-630
10-46 90° Befest. Ø 10-16	02-635
10-46 90° Befest. Ø 12,7	02-640
20-60 90° Befest. CM 2	02-645

